

High Resolution  
Single or Dual Channel Graphics  
with Video/Hi-Res Input



## Features

- 128-bit graphics accelerator
- 16 MB display memory
- Supports one display at up to 1600 x 1200 x 16 bpp or two displays at up to 1280 x 1024 x 8 bpp
- Dual channel VGA or LVDS and single channel NTSC/PAL and DVI display modes
- Front panel and/or rear-panel (Pn4) connections
- NTSC/PAL, RGB, and DVI capture up to 1024 x 768
- VxWorks, Linux, LynxOS, and Windows 2K/XP

# TopazPMC

Rastergraf's TopazPMC is a display controller and video capture PMC (PCI Mezzanine Card) board. The card is available with software for a variety of popular operating environments (see page 9).

The TopazPMC is available in both display-only (TopazPMC/1x) and display/capture (TopazPMC/2x) versions. The TopazPMC replaces the earlier StratusPMC and TroposPMC products. Please refer to page 5 for more information. Please contact the Rastergraf if you desire a configuration not shown in this data sheet.

TopazPMC features a Silicon Motion SM731 System On a Chip (SOC) graphics accelerator with 16 Mbytes of on-chip SDRAM. This 128-bit 2D/3D graphics engine supports compatible displays at 1600x1200x16 bpp or 1280x1024x24 bpp. The capabilities of the board are discussed in more detail on the following pages.

Optional features include a Conexant Bt835 NTSC/PAL/S-Video and Analog Devices AD9882 High Speed RGB/DVI digitizers. A loopback can connect Video Output to Input for self-testing.

The standard TopazPMC configurations are controlled by Rastergraf's factory configured I/O Resource Matrix, which maximizes I/O flexibility, enabling most functions on either the front or rear panel. Please refer to page 4 for a block diagram.

## Embedded Life-Cycle Support

Rastergraf's comprehensive selection of PMC, CompactPCI, PCI, and VME display and carrier solutions are designed to satisfy the product life-cycle requirements demanded by the embedded computing market.

## The Embedded Graphics Source.

Rastergraf's SM731-based product line also includes the ruggedized version equivalent to the TopazPMC, which is called the GarnetPMC.

Additional Rastergraf products include:

- Single, dual, and quad display-only PMC.
- Single and dual display/capture with audio I/O PMC
- Single display-only CPCI and PCI
- 3U and 6U VME graphics boards.
- CompactPCI and PCI carriers for one or two PMCs.

Please contact Rastergraf for more information or consult our web page at [www.rastergraf.com](http://www.rastergraf.com).

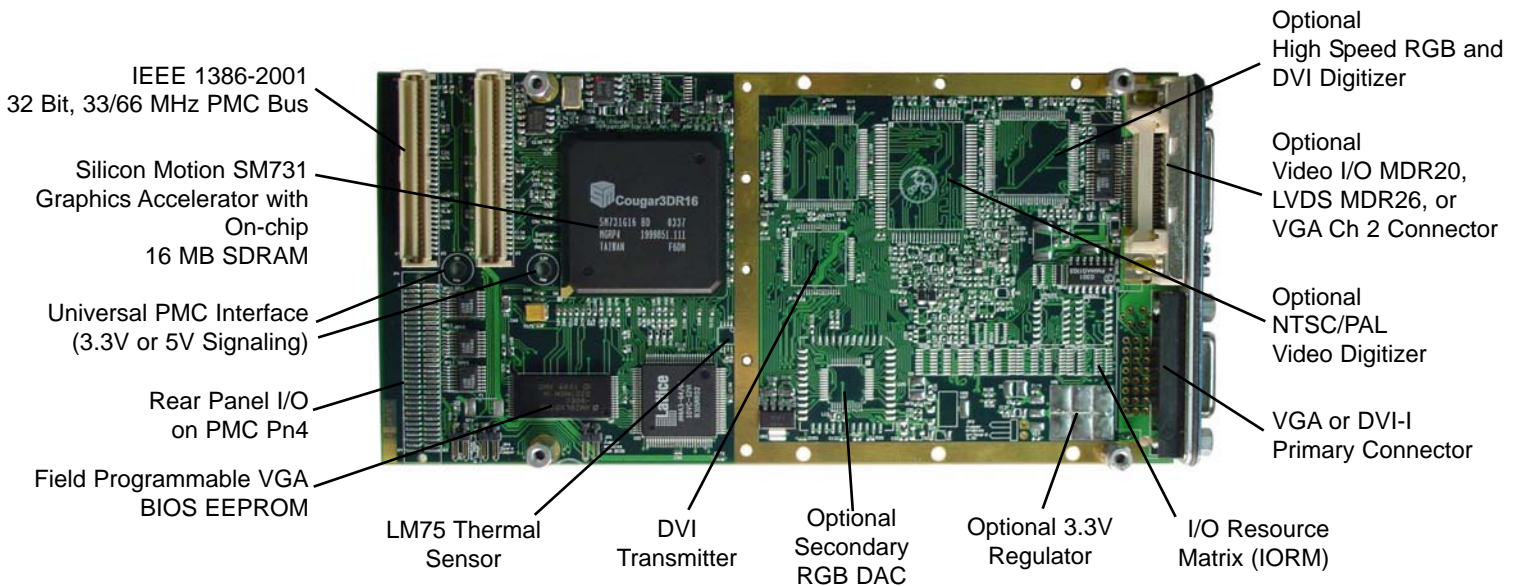

## Features

- Silicon Motion 128-bit 2D/3D graphics controller
- 32-bit, 33/66 MHz PCI interface
- Pixel size is programmable for 8, 16, or 24 bits/pixel
- 16 MB SDRAM Graphics Memory
- Single VGA/DVI output up to 1600 x 1200 @ 16 bpp or 1280 x 1024 @ 24 bpp.
- Dual VGA/DVI outputs up to 1280 x 1024 x 8 bpp (second DVI output requires external VGA/DVI converter)
- Dual LVDS output up to 1024 x 768 x 24 bpp
- Hardware scroll, pan, and cursor
- VGA BIOS support
- Video Input Digitizer supports NTSC/PAL, STANAG 3350 A-C, and High Speed RGB or DVI input up to 1024 x 768
- Special single channel, display-only version supports high accuracy STANAG 3350 A-C
- Flexible assignment of front and rear panel connections
- Optional local 3.3V regulator for hosts that lack 3.3V
- Use on PCI and CompactPCI with a PMC host adapter

# TopazPMC Technical Overview

## Introduction

The TopazPMC contains four major functional blocks: the Silicon Motion SM731 graphics controller, the multimode video digitizers, the BIOS programmer, and the I/O Resource Matrix (IORM).

## System On a Chip Graphics Accelerator

The TopazPMC is powered by a Silicon Motion SM731 SOC graphics accelerator. It includes a 32-bit, 33/66 MHz PCI bus, LVDS encoders, parallel-data flat panel outputs, NTSC/PAL encoder, 235 MHz RAMDAC, and a DMA controller. It supports all ACPI power states. The SM731 includes 16 MB SDRAM. It provides sufficient bandwidth to concurrently support large displays and other graphics and video processing functions.

The SM731's 128-bit Drawing Engine supports 3 ROPs, BitBLT, color expansion, and line draw. It includes an IEEE Floating Point Setup engine as well as a complete 3D rendering engine. The 3D pipeline can setup 6M triangles/second and rasterize at 125 Mpix/second. The dual pipe texture engine can output 250 Mtex/second. It provides mip mapping, alpha blend, specular highlights, stencil planes, fog, anisotropic filter, bump mapping and Z buffer support.

The SM731's Motion Compensation, Video Processor, and Video Capture Units provide superior video quality for real-time video playback and capture. When combined with a fast host CPU, the Motion Compensation block enables full frame playback of DVD video content. The Video Processor supports multiple independent full screen, full motion video windows with overlay. Each video window uses hardware YUV-to-RGB conversion, scaling, and color interpolation.

The programmable video timing ranges from 30 to 150 Hz vertical and 15.7 kHz to 100 kHz horizontal refresh rates, with a pixel clock up to 235 MHz, delivering display formats up to 1600 x 1200 @ 16 bpp or 1280 x 1024 @ 24 bpp.

The graphics display output uses an internal RAMDAC which integrates the graphics and 64 x 64 x 2 bit cursor pixels into 24-bit RGB color values. The analog signals from the RAMDAC are connected to a standard RGBHV (VGA). On TopazPMC/2, Sync-on-Green or Composite Sync is also supported. I2C/DDC lines enable the host computer to control the monitor and local peripheral devices. Using an external VGA-to-DVI converter module (available from Rastergraf), this output can be used to provide a second DVI channel.

The SM731's 24-bit parallel-data output is used on Topaz to drive an external DVI encoder or, alternatively, an Analog Devices ADV7123 for use as a second VGA port. When both channels (either with LVDS or analog) are used, the display resolution is restricted to 1280 x 1024 x 8 bpp or 1024 x 764 x 32 bpp because of limits on the memory bandwidth.

## Video, RGB, and DVI Inputs

The SM731 has a single wide-band 16-bit video input port. It can accept input in YUV or 5:6:5 RGB formats. The TopazPMC uses a PLD-based multiplexer to support Video and RGB/DVI digitizers. One of these sources is selected as the active digitizer. RGB, 8-bit monochrome (G or YUV), or color YUV is then provided to the SM731.

A Conexant Bt835 Video Digitizer selects and decodes 1-of-4 NTSC/PAL composite video or 1-of-3 composite plus S-Video. STANAG 3350 A-C input formats are also supported. The Bt835 provides on-the-fly scaled and clipped digitized video images to the SM731 input port. Image data can be captured by the host CPU using the SM731 DMA to transfer captured data in graphics memory into host memory. A self-test feature can connect the Composite Video Output to a video input.

An Analog Devices AD9882 dual mode digitizer supports high speed RGB or DVI up to 1024x768. RGB input can accept with separate or Sync-On-Green. Although the AD9882 can decode 24-bit RGB, the SM731's 16-bit input port limits RGB input to 5:6:5.

## Field Programmable BIOS

The SM731's auxiliary I<sup>2</sup>C port and a PLD are used to drive the BIOS EEPROM's data and address lines to enable field programming.

## I/O Resource Matrix

The I/O Resource Matrix (IORM) uses factory installed 0-ohm packs to direct the TopazPMC input and output streams to the MDR and DVI front panel connectors and/or the rear panel I/O (Pn4) connector.

## STANAG 3350 A-C Support

A special single channel, display-only version (TopazPMC/1S) processes the sync outputs from the SM731 and generates highly accurate STANAG 3350 A (875 line interlaced). STANAG 3350 B (625 line) and C (525 line) are standard interlaced video formats and are also supported by TopazPMC/1S.

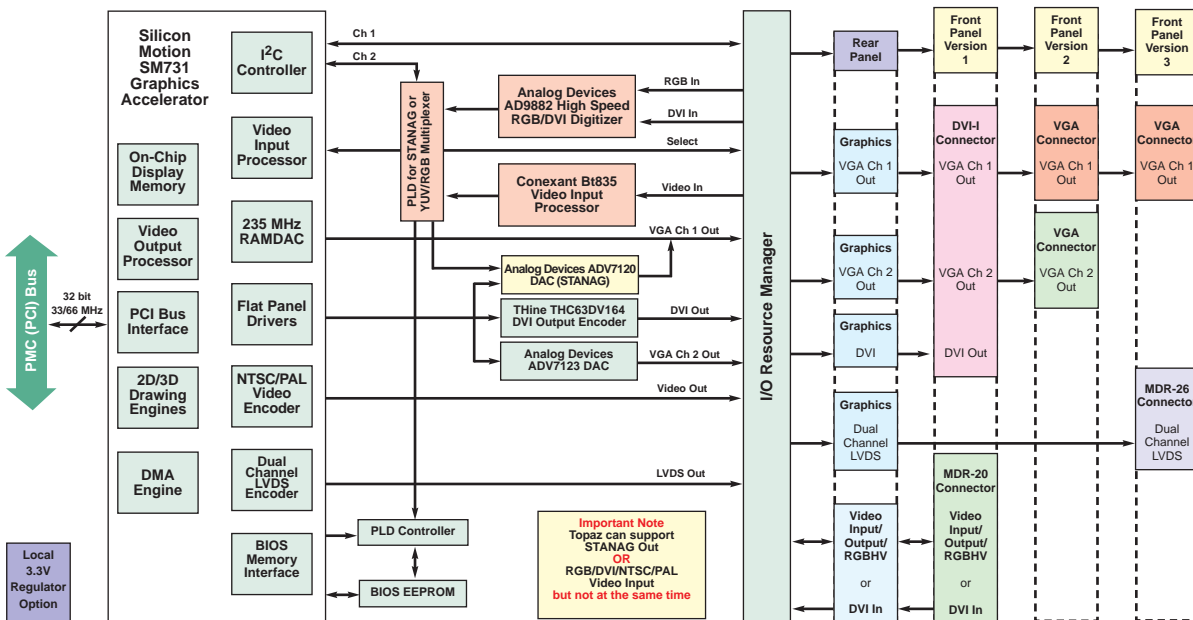

## TopazPMC Functional Diagram

# TopazPMC Inputs and Outputs

## Graphics Output Flexibility

TopazPMC supports a wide range of graphics configurations, directly supporting a single DVI (see DVI Output, below), dual VGA, or dual LVDS outputs. Note that the maximum display resolution in dual display mode is 1280 x 1024 x 8 bpp or 1024 x 768 x 32 bpp. See tables on page 6 for more details.

## Analog Non-Interlaced Video Output

The TopazPMC provides 1 or 2 display channels, each of which supports non-interlaced analog graphics. Output modes are dual VGA (RGBHV), and additionally for TopazPMC/2 boards, RGB with Sync-On-Green and RGB with separate composite sync.

## Digital DVI Output

The TopazPMC provides an industry standard DVI output which uses a four differential pair interface. With the use of an external VGA-to-DVI converter module (available from Rastergraf), two DVI outputs can be supported.

## LVDS Outputs

The TopazPMC provides single-link, dual display or dual-link, single display LVDS outputs, which use a five differential pair interface supporting a variety of resolutions

## Video Inputs

TopazPMC provides a single 16-bit (5-6-5) video input channel that supports a high-res input mode (up to 1024 x 768) DVI or RGBHV or a 1-of-4 composite (NTSC/PAL/SECAM) or single component (S-Video) input.

## Video Output

The SM731 graphics controller contains an NTSC/PAL encoder which provides video (Composite/NTSC/PAL and component S-Video) output, independent of the VGA output.

## STANAG 3350 A-C Output (TopazPMC/1S)

Sync reconstruction is used to generate the correct composite waveforms for STANAG 3350 A-C. To accomplish this on the Topaz, certain logic elements are taken over, including the video input multiplexer and the Ch 2 VGA DAC. This results in having just a single display output, and no video capture capability. However, the STANAG implementations are very good, even including negative (below ground) sync. Properly programmed (using Rastergraf software) the TopazPMC/1S (or its rugged equivalent GarnetPMC/1S) is highly compliant to STANAG 3350 A-C in all aspects.

# I/O Configuration Matrix Block Diagram

Using 0 Ohm links, the I/O can be directed to the PMC P4 rear panel connector or the front panel connectors, which can be DVI+VGA, VGA+VGA, DVI+MDR20 or DVI+MDR26, depending on the application. A DVI-I breakout cable provides

standard connectors for DVI-D and VGA channels 1 and 2. The following diagram illustrates the way the I/Os can be linked to the connectors.

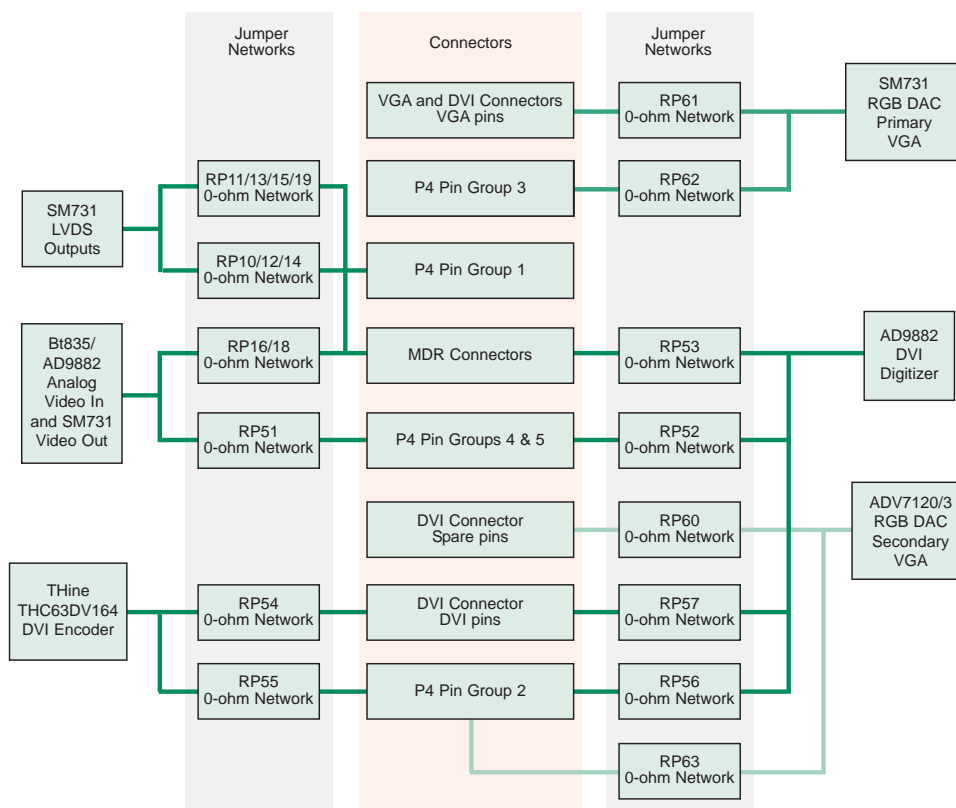

# Configurations

While there are many possible combinations of front and rear panel connections, the following table lists the most common versions.

Except for the TopazPMC/1V and /1S, multiple functions are allocated to each connector. Special breakout cables are available from Rastergraf to enable access to the functions.

For the TopazPMC/1L, standard VGA and a single composite video output share the VGA connector.

For all versions of the TopazPMC/2x, the DVI-I connector brings out DVI and both VGA channels. The MDR20 connector provides several combinations of video out, DVI-In, and RGBHV In (see the table immediately below).

Please contact the factory if you have a special configuration requirement. Also, refer to the User's Manual, Section 2.6 and Chapter 3, which provide comprehensive information about connectors and cabling.

Topaz Version	Use Breakout Cable(s) (see page 6)	MDR 20/26 Pinout	DVI Pinout	VGA out Ch 1	VGA out Ch 2	DVI Out Ch 1	DVI Out Ch 2	LVDS Out Ch 1&2 (note 3)	NTSC/PAL RGBHV Video In	NTSC/PAL Video Out	DVI In	Legacy Product Equivalent
TopazPMC/1V	Standard VGA cables user supplied for Pn4			VGA 1	VGA 2		note 1	Pn4 Pin Grp 1				TroposPMC
TopazPMC/1L	VGA: A31-00735-3012 user supplied for Pn4	26C		VGA-1			note 1	MDR26		VGA 1 comp out		
TopazPMC/1S	Standard VGA to 5 BNC			VGA 1				Pn4 Pin Grp 1				DurosPMC/S
TopazPMC/1R2	user supplied			Pn4 Pin Grp 3		Pn4 Pin Grp 2	note 1	Pn4 Pin Grp 1				DurosPMC TroposPMC/RIO2
TopazPMC/2A	DVI: A31-00735-1012 MDR: A31-00735-6036 user supplied for Pn4	20A	D1	DVI-I	DVI-I	DVI-I	note 1	Pn4 Pin Grp 1	MDR20 note 2	MDR20 note 2	Pn4 Pin Grp 2	StratusPMC StratusPMC/MAX
TopazPMC/2B	DVI: A31-00735-1012 MDR: A31-00735-6036 user supplied for Pn4	20A	D2	DVI-I	DVI-I		note 1	Pn4 Pin Grp 1	MDR20 note 2	MDR20 note 2	DVI-I	StratusPMC/FDI1
TopazPMC/2C	DVI: A31-00735-1012 MDR: A31-00735-5012 user supplied for Pn4	20B	D1	DVI-I	DVI-I	DVI-I	note 1	Pn4 Pin Grp 1			MDR20 note 2	StratusPMC/FDI2
TopazPMC/2R3	user supplied			Pn4 Pin Grp 3		Pn4 Pin Grp 2		Pn4 Pin Grp 1	Pn4 Pin Grp 4	Pn4 Pin Grp 5		StratusPMC/RIO3
TopazPMC/2R5	user supplied			Pn4 Pin Grp 3	Pn4 Pin Grp 2			Pn4 Pin Grp 1	Pn4 Pin Grp 4	Pn4 Pin Grp 5		StratusPMC/RIO5

Note 1: requires optional, external VGA-to-DVI module

Note 2: Stratus uses an MDSM15 connector which is not compatible with MDR20.

Note 3: MDR26 pinout is compatible with standard 3M CameraLink cables. LVDS can be set up as dual channel, single link or single channel, dual link.

## TopazPMC Front Panels

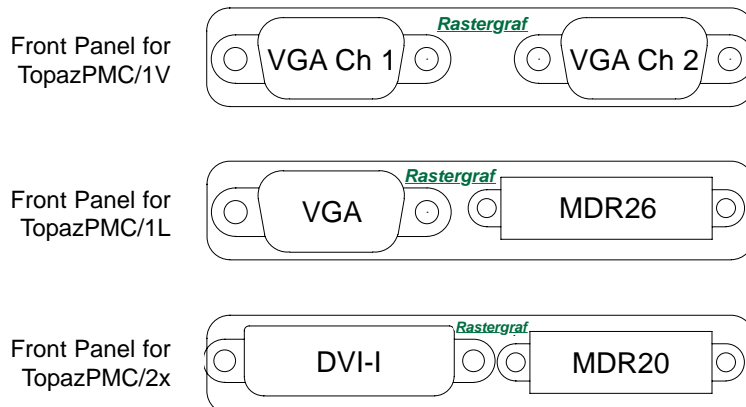

# TopazPMC Cables

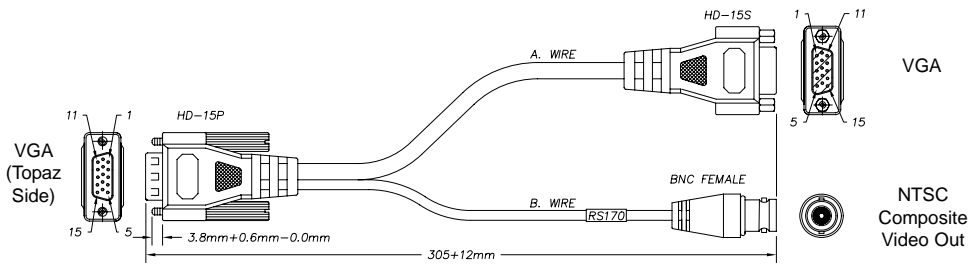

A31-00735-3012 (VLG-2/1) cable assembly

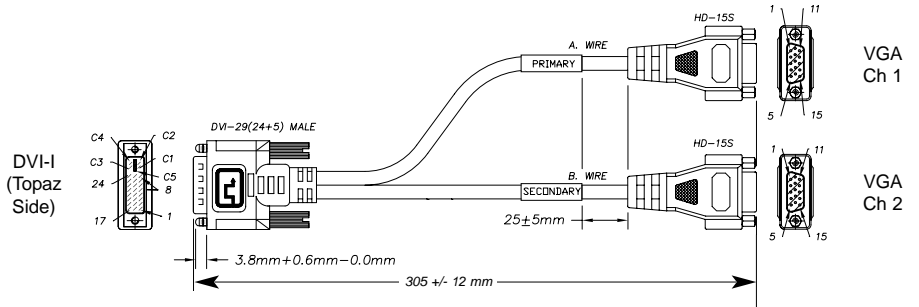

A31-00735-1011 (VSG-2/1) cable assembly

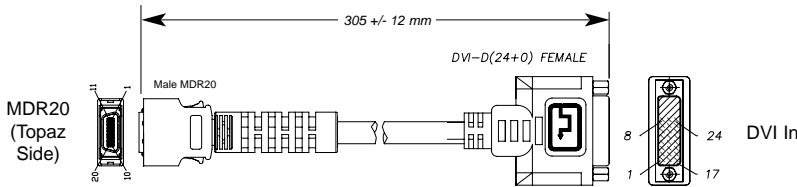

A31-00735-5012 (VLG-1/1) cable assembly

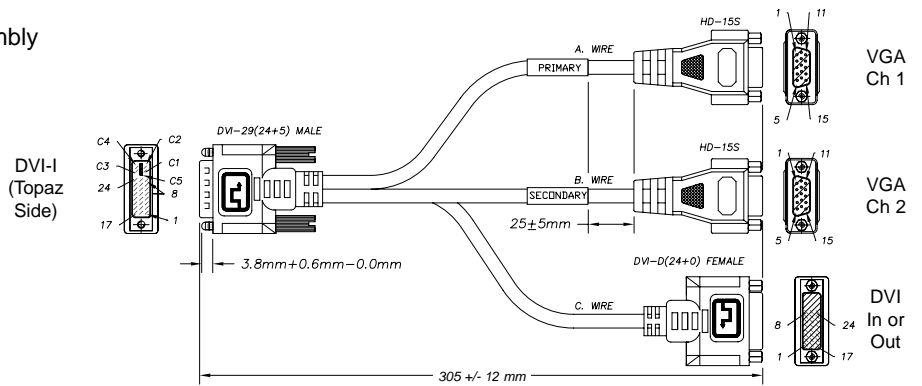

A31-00735-1012 (VSG-3/1) cable assembly

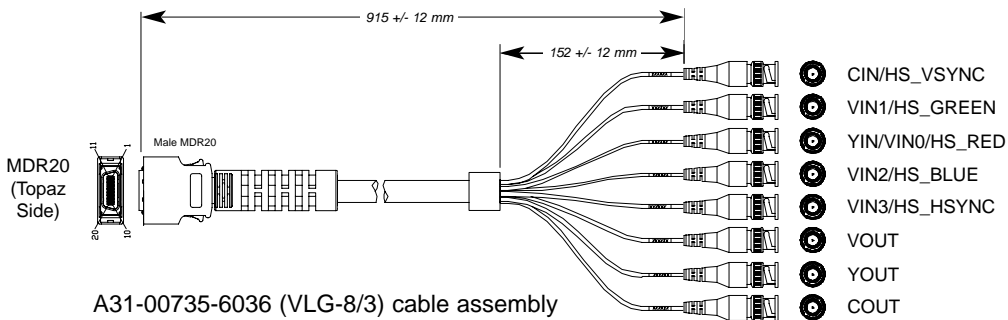

A31-00735-6036 (VLG-8/3) cable assembly

# Display Formats and Output Usage

The TopazPMC is quite flexible in the way that the outputs can be set up. It has two independent timing generators (but only one drawing engine). The following table demonstrates the

breadth of outputs available. Please contact the factory if a special display mode is required.

Video Mode	Resolution	Pixel Size (bits)	Windows Format	Refresh Freq. (Hz)	Output Channel	Notes
Single Analog Non-Interlaced	up to 1600x1200	8,16,32	UXGA max	60,75	Analog 1 or 2	16 bpp@1600x1200
Dual Analog Non-Interlaced	up to 800x600	8,16,32	SVGA max	60,75	Analog 1 and 2	
	1024x768	8,16,32	UVGA	60	Analog 1 and 2	
	1280x1024	8	SXGA	60	Analog 1 and 2	
Analog Interlaced	RS-170 640x480	8,16,32		30	Analog 1	
NTSC/PAL Encoder	PAL 768x575	8,16,32		25	CV	
	NTSC	8,16,32		30	CV	
	S-Video (Y/C)	8,16,32		30	CV	
STANAG 3350	Class A/B/C	8,16,32		30/25/30	Analog 1	LVDS, DVI, Analog 2 n/a
Digital DVI	up to 1600x1200	8,16,32	UXGA max	60	Analog 2	16 bpp@1600
Single Link, Dual Display LVDS	up to 1024x768	8,16,32	UVGA	60	LVDS 1 and 2	85 MHz max
Dual Link, Single Display LVDS	up to 2048x1536	8,16,32	QXGA	60	LVDS 1 and 2	2 Pixel Mode

## TopazPMC Display/Capture Maximum Capabilities

The SM731 Graphics Controller is a flexible chip. It supports a single input capture channel as well as up to two independent outputs. It has windowing capabilities and a 128-bit high-performance drawing engine. But, the overall throughput is handicapped somewhat by a 64-bit memory bus. This section presents some data about the practical limits of the SM731. These sorts of limitations are common in graphics chips, but they are not usually presented to the customer.

The following chart shows the results of empirical tests designed to test the limits of the display/capture capabilities.

There may be cases where a format that was observed to be clean might not be with high drawing engine activity. In order to avoid application software dependencies, special test software was used, not SDL or X Windows. However, similar behavior has been observed with them.

The entries are coded: for example, 1600-8-63 means 1600x1200, 8 bpp, 63 Hz vertical refresh. Other combinations are possible, and some modes (e.g. 1280x1024 capture) are possible when conditions are right. Please refer to the User's Manual, Section 2.5, for more information.

Ch 2 (DVI/VGA)	Ch 1 (VGA only)	Ch 2 Capture Window	Ch 1 Capture Window
1600-8-63	inactive	1024-75	inactive
1600-8-73	inactive	640-60	inactive
1600-8-77+	inactive	inactive	inactive
1600-16-48	inactive	1024-75	inactive
1600-16-62	inactive	640-60	inactive
1600-16-77+	inactive	inactive	inactive
1280-8-85+	inactive	1024-75	inactive
1280-8-85+	inactive	640-60	inactive
1280-8-85+	inactive	inactive	inactive
1280-32-52	inactive	1024-75	inactive
1280-32-63	inactive	640-60	inactive
1280-32-75	inactive	inactive	inactive
1600-16-58	1280-32-60	inactive	inactive
1280-8-73	1280-8-74	1024-75	inactive
1280-8-73	1280-8-74	inactive	1024-75
1280-8-45	1280-8-46	1024-75	1024-75
1280-8-85+	1280-8-85+	inactive	inactive
1280-32-59	1280-32-60	inactive	inactive
1024-32-62	1024-32-63	640-75	640-75
1024-32-85+	1024-32-86+	inactive	inactive

# Video/RGB/DVI Input Capabilities

The TopazPMC has both low (Bt835) and high speed (AD9882) digitizers. Together, they can digitize a wide range of

input signals. A loopback can connect the composite Video Output to Video Input 1 (on the Bt835) for self-testing.

Video Mode	Resolution	Pixel Size (bits)	Refresh Freq. (Hz)	Input Channel	Input Multiplexer	Sync On Green	Clip and Scale?	Notes
Analog Non-Interlaced (RGB)	up to 1024x768	16	60 max	AD9882	no	optional	no	RGB = 565
Analog Interlaced (RGB)	STANAG 3350 A-C	16	30 max	AD9882	no	yes	no	RGB = 565
Analog Interlaced (composite)	RS-170 640x480	16	30	Bt835	1 of 3	n/a	yes	YUV
	RS-343 875 Line	16	30	Bt835	1 of 3	n/a	yes	YUV
	PAL 768x575	16	25	Bt835	1 of 3	n/a	yes	YUV
	NTSC	16	30	Bt835	1 of 3	n/a	yes	YUV
	S-Video (Y/C)	16	25 or 30	Bt835	no	n/a	yes	YUV
Digital DVI	up to 1024x768	16	60 max	AD9882	no	n/a	no	RGB = 565

## Ruggedization

Rastergraf is not in the militarized business. The intent of the following table is to illustrate how the Rastergraf graphic boards fit into the standard ruggedized classes.

Rastergraf boards use standard distribution grade derated commercial temperature range or industrial temperature range components. No formal component tracking is maintained.

Spec	Air-Cooled Level 0	Air-Cooled Level 50	Air-Cooled Level 100	Air-Cooled Level 200	Conduction-cooled Level 100	Conduction-cooled Level 200
Graphics Board(s)	Argus Gemini Sirena Eclipse3 Topaz Garnet	Gemini Sirena Eclipse3 Topaz Garnet	Gemini Sirena Eclipse3 Topaz Garnet	Eclipse3 Topaz Garnet	Garnet	Garnet
Operating Temperature (4, 6)	0°C to 50°C	-20°C to 65°C	-40°C to 71°C	-40°C to 85°C	-40°C to 71°C	-40°C to 85°C
Storage Temperature	-40°C to 85°C	-40°C to 85°C	-55°C to 125°C	-55°C to 125°C	-55°C to 125°C	-55°C to 125°C
Humidity Operating	0 to 95% non-condensing	0 to 100% non-condensing	0 to 100% non-condensing	0 to 100% non-condensing	0 to 100% non-condensing	0 to 100% non-condensing
Humidity Storage	0 to 95% condensing	0 to 100% condensing	0 to 100% condensing	0 to 100% condensing	0 to 100% condensing	0 to 100% condensing
Vibration Sine (1)	2 g peak 15-2 kHz	2 g peak 15-2 kHz	10 g peak 15-2 kHz	10 g peak 15-2 kHz	10 g peak 15-2 kHz	10 g peak 15-2 kHz
Vibration Random (2)	0.01 g2/Hz 15-2 kHz	0.02 g2/Hz 15-2 kHz	0.04 g2/Hz 15-2 kHz	0.04 g2/Hz 15-2 kHz	0.1 g2/Hz 15-2 kHz	0.1 g2/Hz 15-2 kHz
Shock (3)	20 g peak	20 g peak	30 g peak	30 g peak	40 g peak	40 g peak
Conformal Coat (5)	optional	optional	optional	optional	yes	yes
Ordering Option (7)	/CA or /CS	/A5A or /A5S	/A1A or /A1S	/A2A or /A2S	/C1A or /C1S	/C2A or /C2S

### Notes:







- Sine vibration based on a sine sweep duration of 10 minutes per axis in each of three mutually perpendicular axes. May be displacement limited from 15 to 44 Hz, depending on specific test equipment. **Shock and Vibration values are by design and not tested in production.**
- Random vibration 60 minutes per axis, in each of three mutually perpendicular axes.
- Three hits in each axis, both directions, 1/2 sine and saw tooth. Total 36 hits.
- Standard air-flow is 8 cfm at sea level. Some higher-powered products may require additional airflow. Consult the factory for details.
- Conformal coating type to be specified by customer. Consult the factory for details..
- Temperature is measured at the card interior (not at edge) using on-board LM75 temperature monitor.
- Last letter in ordering option: A for Acrylic Conformal Coating, S for Silicone Conformal Coating



# Graphics Software Support

SDL Subroutine Library includes video capture and Built-In Self Test modules  
 WindML support (requires SDL) including video input extensions  
 Accelerated X Server with Xv video input extensions  
 Windows 2K/XP drivers including accelerated DirectX

## Software Support Matrix

			Video Input	DirectX 7	Built-In Self-Test (via SDL)
<b>Solaris x86</b> 	✓	✓	✓		
<b>VxWorks x86/PowerPC</b> 	✓		✓		✓
<b>Windows 2K/XP</b> 			✓	✓	
<b>Linux x86/PowerPC</b> 	✓	✓	✓		✓
<b>LynxOS PowerPC</b> 	✓	✓	✓		

## SDL Graphics Library

SDL is a graphics library designed to be a device-independent programming interface. SDL is ideally suited to demanding board level and embedded systems applications. Drivers are available for selected host CPU boards and operating systems. SDL is supplied in object library format, which means that its target code size can be controlled by limiting the number of functions used in a given application. SDL has been designed to run on any CPU and operating system that uses linear addressing and is supported by the GNU C compiler and linker.

SDL is easy to use. It includes a complete set of graphics primitives that interface to the SM731 graphics controller's accelerated functions. SDL also supports video capture capabilities. All graphics primitives are drawn as single pixel lines. Rectangles, polygons, circles, ellipses, and chords can be filled with a solid color or stipple patterns.

Complete information about SDL is contained in the Standard Drawing Library C Reference Manual that is available for download from our web site at <http://www.rastergraf.com>.

### SDL Feature Summary

- Solid (thin and wide) and dashed lines, polylines, and rectangles
- Pixblits to/from the display and host memory
- Filled and hollow polygons, ellipses, circles, sectors, and chords
- Solid and Pattern Fills - Pixel Processing
- Proportional and Fixed Width Fonts
- Clipping Rectangle and Logical Origin
- VGA 640x480 to 1600x1200 (dual display)
- 8/16/24 bpp
- DVI Output
- Sync On Green and Composite Separate Sync outputs (TopazPMC/2)
- Video Capture - NTSC/PAL, S-Video via BT835
- Video Capture - high speed DVI, RGB, or monochrome via AD9882
- TV Out - NTSC/PAL
- STANAG-A-C Timing (requires special order board - TopazPMC/1S)

# Product Specifications

<b>Graphics Controllers</b>	Silicon Motion SM731, 32-bit/66 MHz PCI
<b>Maximum Dot Clock</b>	235 MHz
<b>Horizontal Scan Rates</b>	31.5 to 115 kHz
<b>Display Memory</b>	16 MB SDRAM
<b>Display Colors</b>	16.7 Million @ 24-bits, 256 @ 8-bits
<b>Digitizers</b>	Conexant Bt835 with 4 input mux and S-Video supports NTSC/PAL cameras  Analog Devices AD9882 RGB/DVI supports RGBHV, RGB with Sync-On-Green or Composite Sync, STANAG 3350 A-C, or DVI inputs up to 1024x768. Output to SM731 is either 5:6:5 RGB or YUV.
<b>Environment</b>	Temperature: 0°C to +70°C, operating, -55°C to +85°C, storage Humidity: 5% - 95% non-condensing
<b>Power Requirements</b>	+3.3V ±5%, 0.3A +5V ±5%, 0.6A Local 3.3V regulator option if no host 3.3V.  Measurements do not include 5V power sourced to Ch 1 & Ch 2 VGA/DVI (limited to 1A total).
<b>Compatibility</b>	IEEE 1386-2001, 32-bit, 66 MHz Universal PCI Bus signaling (5V and 3.3V)
<b>PCI Device IDs and Interrupts</b>	SM731 IDSEL = PMC IDSEL, INTA LM75 INTB
<b>PCI Subsystem Vendor ID</b>	0x10F0 (Vendor Code)
<b>PCI Subsystem Device ID</b>	0x00C7 (TopazPMC Identifier)
<b>Dimensions</b>	149 mm x 74 mm
<b>Board Connections</b>	Controlled by the IO Resource Director
<b>Front Panel</b>	VGA or DVI-I + MDR20 or MDR26
<b>Rear (PMC Pn4)</b>	64 pin PMC connector
<b>Cautionary Note</b>	<b>DVI and LVDS front panel and Pn4 rear panel cabling require matched length signal sets. Other I/Os require signal+ground pairs.</b>
<b>I/O Resource Matrix (IORM) (set up at factory)</b>	<b>Connections either to front or rear but not both. Not all choices are available simultaneously. Contact factory for details.</b>  <b>DVI connector:</b> 2 x VGA and DVI In or Out  <b>MDR20 Connector:</b> NTSC/PAL+Video I/O+ High Speed RGB or DVI In  <b>MDR26 Connector:</b> LVDS dual channel, (/1L board only) 3M CameraLink cable compatible  <b>Rear (PMC Pn4):</b> Dual LVDS (always) 2 x VGA, DVI In or Out, High Speed RGB In + NTSC/PAL Video I/O
<b>Analog Monitor Support</b>	VGA. Non-interlaced up to 1600x1200 @ 16 bpp or 1280 x 1024 @ 24 bpp. TopazPMC/2 also supports Sync-On-Green or Composite Sync.
<b>Composite Video Signal</b>	1 Volt peak to peak, consisting of: 660 mV Reference White 54 mV Reference Black 286 mV Sync
<b>DVI Digital Monitor Support</b>	Available on TopazPMC/2 versions 1600x1200 @ 16 bpp or 1280 x 1024 @ 24 bpp
<b>LVDS Digital Monitor Support</b>	Dual channel, 1024x768x24 bpp each or single channel, 2048x1536x24 bpp
<b>VGA BIOS</b>	Allows board to function as system console.
<b>Maintenance Features</b>	DDC-2B control enables system software to interrogate monitor for type and capabilities; RAMDAC sense function can detect monitor connections; LM75 thermal sensor can report board temp; composite video In/Out loopback
<b>Power-management capabilities</b>	Depending on operating system support, most devices can be at least partially powered down.

# Ordering Information

## TopazPMC General Description

Silicon Motion SM731 Graphics Accelerator, 16 MB SDRAM, I/O Resource Director, dual VGA out, dual channel LVDS, and BIOS.

### TopazPMC/1V

Dual front panel VGA connectors

### TopazPMC/1L

VGA (Ch 1 only) plus MDR26 with LVDS Ch 1 and Ch 2 (follows MDR26 Pinout 26C - see User's Manual, Table 3-7).

### TopazPMC/1S

VGA Ch 1 supporting STANAG 3350 A-C outputs on RGBHV

**TopazPMC/2[n]** versions include basic feature set plus Conexant Bt835 video digitizer, Analog Devices AD9882 High Speed RGB/DVI Digitizer, NTSC/PAL video out, support for RGB output with Sync-On-Green or Composite Sync, and digital out (single DVI and dual LVDS). Replace VGA connector with DVI-I and MDR20 connectors (breakout cable required to access all functions)

Must specify **[n]**, which determines the use of the DVI-I connector (DVI in or out) and MDR20 (see Configurations Table on page 5).

Second DVI is out available with the use of an external VGA to DVI converter (see below, VGD-1).

## Options

### /R[x]

Rear panel I/O. No front panel connectors. Must specify **[x]**, which determines the Rear I/O configuration. See Configurations Table on Page 5 for pinout details.

### /V

Add local 3.3V regulator for systems without 3.3V on PMC bus.

### A31-00735-1011 (VSG-2/1)

DVI-I to dual VGA breakout cable, 1 ft.

### A31-00735-1012 (VSG-3/1)

DVI-I to dual VGA plus DVI-D breakout cable, 1 ft.

### A31-00735-3012 (VLG-2/1)

VGA to VGA + BNC breakout cable, 1 ft.

### A31-00735-5012 (VLG-1/1)

MDR20 to DVI In cable, 1 ft.

### A31-00735-6036 (VLG-8/3)

MDR20 to 8 BNC, 3 ft.

### VGD-1

Convert high resolution VGA to DVI. Enables TopazPMC to supply dual DVI channels.

## Software:

### SDL/RX.X

SDL graphics library for x86/PPC VxWorks, x86/PPC Linux, x86 Solaris, or PPC LynxOS.

### WML/RX.X

WindML for x86/PPC VxWorks. Includes video extensions

### Windows Drivers

Display, video input, and DirectX 7 drivers for Windows 2K/XP.

### DRV/LN/RX.X

Video Input and 2D accelerated X-Windows DDX drivers for x86/PPC Linux, x86 Solaris, or PPC LynxOS.

**NOTE:** /RX.X is software revision number, subject to change.

[www.rastergraf.com](http://www.rastergraf.com)

## Rastergraf, Inc.

1804-P SE First Street  
Redmond, Oregon 97756  
tel: +1 (541) 923-5530  
fax: +1 (541) 923-6475  
email:sales@rastergraf.com

Important Notices:

Trademarks are property of their respective owners.

The TopazPMC is manufactured and sold under license from Curtiss-Wright Controls Embedded Computing. Contact Rastergraf, Inc. for additional information.