

C320Turbo Series

8 to 32-port intelligent RS-232 Universal PCI and ISA serial boards



- > Supports 128 high-performance serial ports per system
- > Dramatically decreases host CPU loading
- > Modular design makes port expansion easy
- > Monitor transmission status with LEDs on the module and two 7-segment displays
- > Drivers provided for a broad selection of operating systems
- > 460.8 Kbps maximum baudrate



The certification logos shown here apply to some or all of the products in this section. For details, see "Regulatory Approvals" under "Specifications" below.

Overview

The intelligent C320Turbo serial boards are expandable and flexible COM/TTY solutions for RS-232 applications that require connecting up to 128 serial devices to one computer. The C320Turbo's on-board

CPU and large dual-port memory take the load off host systems whose performance and scalability are critical for large-scale systems.

Drivers Provided for a Broad Selection of Operating Systems

In addition to providing COM port drivers for all major operating systems, Moxa also supports the following dedicated operating systems for customers' special needs.

- | | |
|--------------------|---------------|
| DOS | QNX 4.2x |
| Windows | Linux 2.4/2.6 |
| Windows (x64) | Linux (x64) |
| SCO UnixWare 7 | |
| SCO OpenServer 5/6 | |
| SCO UNIX SVR 4.2 | |



Dramatically Decreases Host Computer's CPU Loading

The C320Turbo boards have a state-of-the-art onboard CPU that dramatically reduces the host computer's loading **by up to 68%*** for applications that use 32 ports per board.

*Testing Environment

- Pentium 4, 1.8 GB CPU, 128 MB RAM
- Windows 2000 Professional
- Moxa PComm Pro Performance Analyzer
- 115.2 Kbps, full duplex, 24-hour burn-in

12% Loading

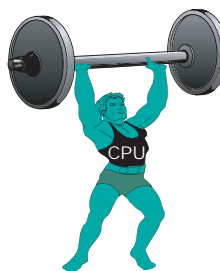

Intelligent Board

80% Loading



Non-Intelligent Board

Specifications

Hardware

Comm. Controller: 16C550C or compatible x 8

Bus:

C320Turbo/PCI: 32-bit Universal PCI

C320Turbo: 16-bit ISA

Connector: DB25 female

Processor: TMS320BC52-40 RISC CPU

Memory: 512 KB

Serial Interface

Number of Ports: 32 per control board (max.)
Serial Standards: RS-232 (RS-422 available with desktop option)
Max. No. of Boards per PC: 4

Performance

Baudrate: 50 bps to 460.8 Kbps

Serial Communication Parameters

Data Bits: 5, 6, 7, 8
Stop Bits: 1, 1.5, 2
Parity: None, Even, Odd, Space, Mark

IRQ:

C32010T/PCI: Assigned by BIOS
 C32010T: 2 (9), 3, 4, 5, 7, 10 (default), 11, 12, 15

Serial Signals

RS-232: TxD, RxD, RTS, CTS, DTR, DSR, DCD, GND
RS-422: TxD+/-, RxD+/-, RTS+/-, CTS+/-, GND

Driver Support

Operating Systems: Windows (2000, XP/2003/Vista/2008 x86/x64, 9X/ME/NT), DOS, Linux 2.4, Linux 2.6 (x86/x64), SCO Open Server 5/6, UnixWare 7, QNX 4/6

Physical Characteristics

Dimensions:
 C32010T/PCI: 90 x 120 mm (3.54 x 4.72 in)
 C32010T: 107 x 158 mm (4.21 x 6.22 in)

Environmental Limits

Operating Temperature: 0 to 55°C (32 to 131°F)
Operating Humidity: 5 to 95% RH
Storage Temperature: -20 to 85°C (-4 to 185°F)

Regulatory Approvals

FCC: Part 15 Class A
EMS: EN61000-4-2, EN61000-4-3, EN61000-4-4, ENV5204

Power Requirements

Power Consumption:
 C32010T/PCI: 500 mA max. @ +5 V
 C32010T: 840 mA max. @ +5 V

Warranty

Warranty Period: 5 years
Details: See www.moxa.com/warranty

Dimensions

Desktop Solution

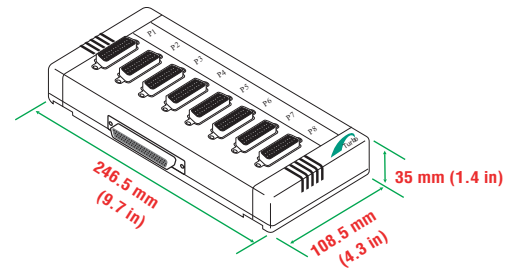
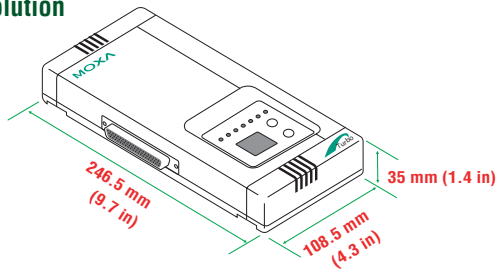

Rackmount Solution

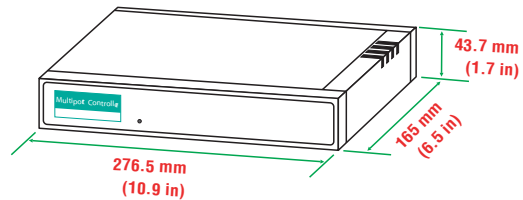
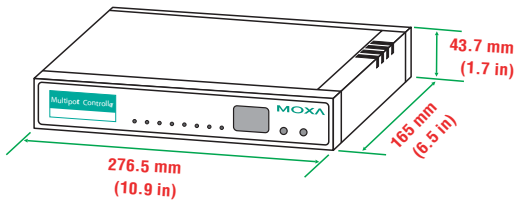

	C32010T/ PCI	C32010T	C32030T	C32045T	C32047T	C32061T
Dimensions (mm)	120 x 90 x 15	158 x 107 x 15	247 x 108 x 35	247 x 108 x 35	247 x 108 x 35	247 x 108 x 35
Weight (g)	90	120	425	500	485	488
Power Requirements	0.5A (+5V)	0.84A (+5V)	0.59A (+5V)	0.28A (+5V) 0.095A (+12V) 0.06A (-12V)	0.28A (+5V) 0.095A (+12V) 0.06A (-12V)	0.485A (+5V)

	C32065T	C32071T	C32080T	C32081T	C32082T	C32083T
Dimensions (mm)	247 x 108 x 35	247 x 108 x 35	277 x 165 x 44	277 x 165 x 44	277 x 165 x 44	277 x 165 x 44
Weight (g)	525	525	1020	1120	920	1000
Power Requirements	1.32A (+5V)	0.28A (+5V) 0.095A (+12V) 0.06A (-12V)	0.88A (+5V) 0.095A (+12V) 0.06A (-12V)	1.22A (+5V) 0.19A (+12V) 0.12A (-12V)	0.34A (+5V) 0.095A (+12V) 0.06A (-12V)	0.67A (+5V) 0.19A (+12V) 0.12A (-12V)

Ordering Information

Package Checklist

- C320Turbo/PCI or C320Turbo board
- 2-meter DB25-M to DB25-F connection cable
- Long-range extension kit (optional)
- Document and Software CD
- Quick Installation Guide (printed)
- Warranty Card

Available Models

Control Boards (must choose one)

C32010T/PCI: Universal PCI board
C32010T: ISA board

External Modules

Rackmount Option

Basic Modules (must choose one)

C32080T: 8 RS-232 ports, 10-pin RJ45 connectors
C32081T: 16-port, RS-232, 10-pin RJ45

Expansion Modules (optional)

C32082T: 8 RS-232 ports, 10-pin RJ45 connectors
C32083T: 16 RS-232 ports, 10-pin RJ45 connectors

Long-range Extension Kit (optional)

C32050T: Includes the following items

- 2 meter DB25-M to DB25-F 10-wire cable (generally used for set-up)
- 90-240 VAC switching power adaptor (0-30°C operating temperature)

NOTE: Build your own DB25-M to DB25-F 10-wire cable for connecting up to 100 meters.

Desktop Option

- CPU module
- One or more UART modules (32 ports maximum per board)

Rackmount Option

- Basic module
- Zero or more expansion modules (32 ports maximum per board)

Connection Cable (required)

C32020T: 2 meter DB25-M to DB25-F cable with 25 pins for short-range usage

Desktop Option

CPU Module (required)

C32030T: Connects directly to one UART module

8-port UART Modules (choose at least one)

C32045T: RS-232, DB25-F connectors
C32047T: RS-232, DB25-M connectors
C32071T: RS-232, DB25-F connectors (25 KV ESD surge protection)
C32061T: RS-422, DB25-F connectors
C32065T: RS-422, DB25-F connectors (2 KV optical isolation)

Ordering Examples

Rackmount Ordering Examples

16 RS-232 ports



Control Board: C32010T/PCI
Connection Cable: C32020T
Basic Module: C32081T

32 RS-232 ports



Control Board: C32010T/PCI
Connection Cable: C32020T
Basic Module: C32081T x 1
Expansion Module: C32083T x 1

Rackmount Setup Diagram

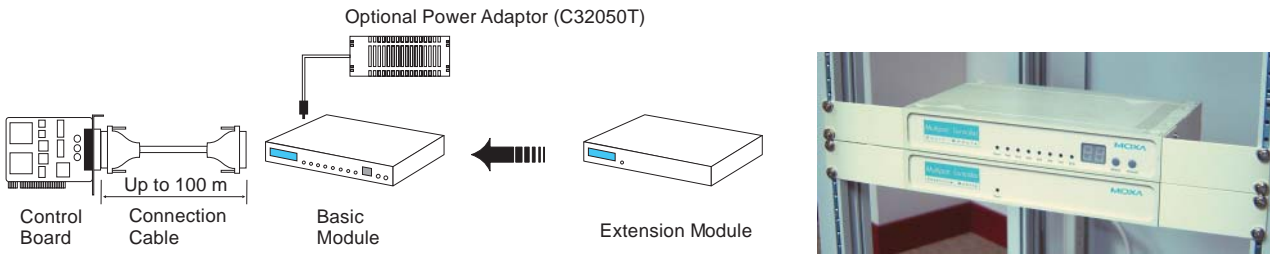

Desktop Ordering Examples

8 RS-232 ports



Control Board: C32010T/PCI
Connection Cable: C32020T
CPU Module: C32030T
UART Module: C32045T x 1

8 RS-232 ports + 16 RS-422 ports



Control Board: C32010T/PCI
Connection Cable: C32020T
CPU Module: C32030T
UART Module: C32045T x 1 + C32061T x 2

16 RS-232 ports



Control Board: C32010T/PCI
Connection Cable: C32020T
CPU Module: C32030T
UART Module: C32045T x 2 or C32047T x 2

32 RS-232 ports



Control Board: C32010T/PCI
Connection Cable: C32020T
CPU Module: C32030T
UART Module: C32045T x 4 or C32047T x 4

Desktop Setup Diagram

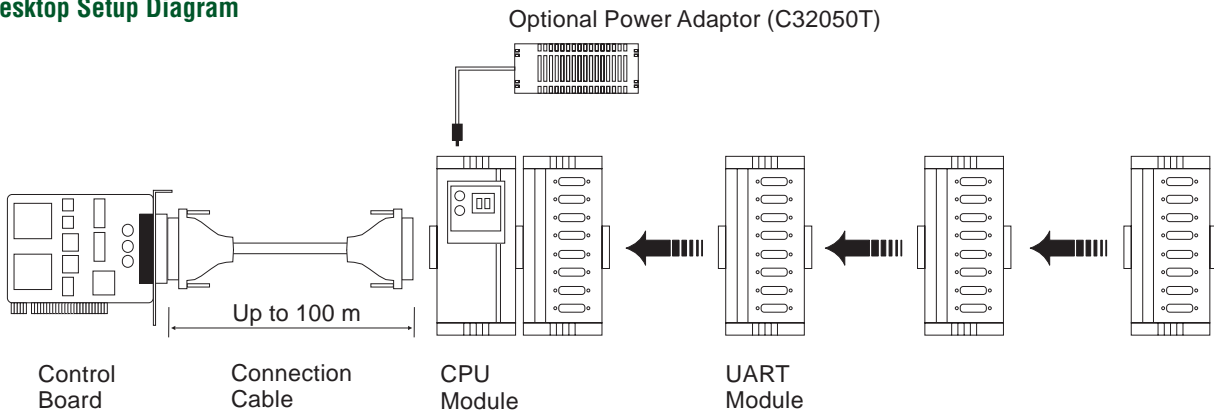

10

Multiport Serial Boards > C320Turbo Series