

MVME5500 Series

VMEbus Single-Board Computer

■ Embedded Computing for
Business-Critical Continuity™

The MVME5500 is the flagship of our VME product line that enables higher levels of performance in a single VMEbus slot

- MPC7457 PowerPC® processor at 1 GHz
- 512KB of on-chip L2 cache and 2MB of L3 cache
- AltiVec coprocessor for high-performance computational applications
- Two banks of soldered flash memory (32MB and 8MB)
- Dual independent 64-bit PCI buses and PMC sites with a bus speed of up to 66 MHz
- Gigabit Ethernet interface plus an additional 10/100BaseTX Ethernet interface
- 64-bit PCI expansion mezzanine connector allowing up to four more PMCs
- I/O compatibility with MVME51xx family
- Support for processor PMCs (PrPMCs)

The Emerson Network Power MVME5500 series is designed to meet the needs of OEMs including those in defense and aerospace, industrial automation and medical imaging market segments. Customers looking for a technology refresh for their application while maintaining backward compatibility with their existing VMEbus infrastructure can upgrade to the MVME5500 series and take advantage of the enhanced performance features.

The MVME5500 utilizes the MPC7457 processor running at 1 GHz, which is ideal for data intensive applications. The MVME5500 provides more than just better processor performance; it also provides balanced performance from the processor, memory, dual independent local buses and I/O subsystems.

The powerful Marvell system controller, with support for a 133 MHz host bus and a 133 MHz SDRAM memory bus, is well matched to the high speed processor. To match the system I/O to the outstanding processor performance, the MVME5500 provides dual 64-bit, 33/66 MHz PCI buses. Each PCI bus has a PMC site supporting cards running at 33 or 66 MHz. The Universe II VME interface and PMCs span connector are isolated from the PMC sites on a dedicated 33 MHz PCI bus segment so that both PMC sites are capable of 66 MHz operation.

The MVME5500 also offers a Gigabit Ethernet interface, a 10/100BaseTX Ethernet interface and two serial ports. All of this adds up to a set of well-balanced, high-performance subsystems for unparalleled performance.

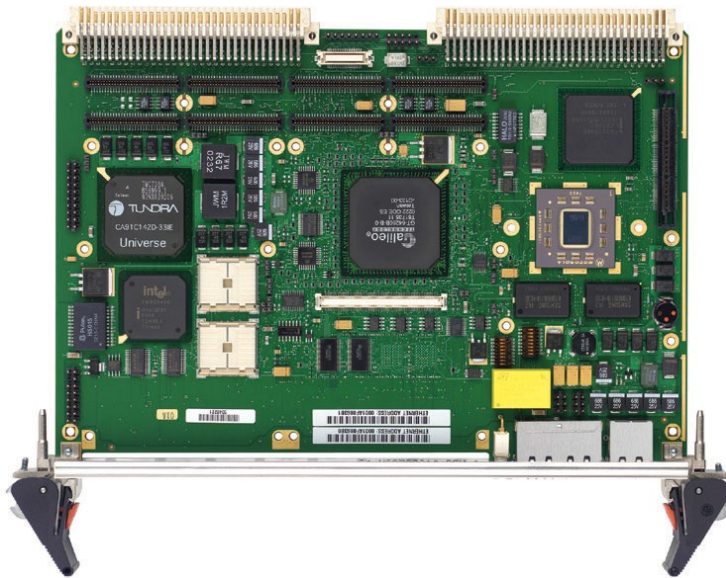

EMERSON™
Network Power

MVME5500 Block Diagram

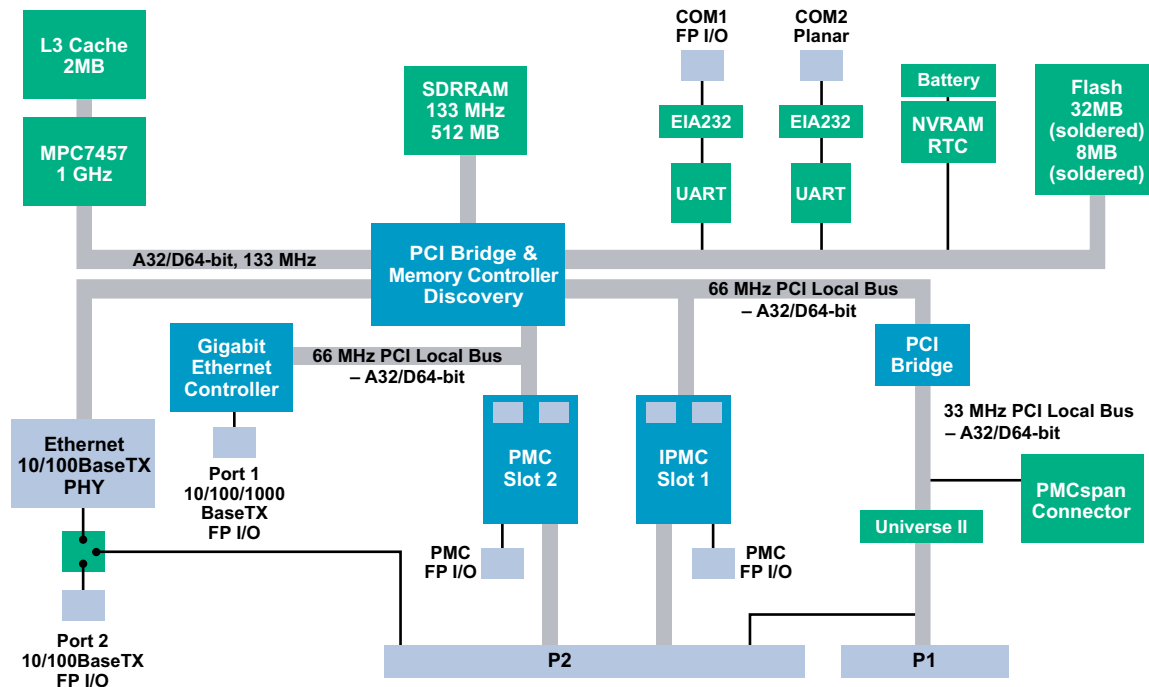

Backwards Compatibility

The MVME5500 continues the direction that Emerson started with the MVME5100 series of providing a migration path from Emerson's embedded controllers and single-board computers (SBCs) to a single platform. This migration path enables OEMs to support varying I/O requirements with the same base platform, simplifying part number maintenance, technical expertise requirements and sparing.

The MVME5500 series offers customers a migration path from the MVME2300, MVME2400, MVME2600, MVME2700 and MVME5100 boards to allow them to take advantage of features such as the MPC7455 processor, Gigabit Ethernet and dual independent 33/66 MHz PMC sites.

P2 I/O MODES

The MVME5500 series supports two, jumper-configurable P2 I/O modes: PMC mode and IPMC mode. PMC mode is backward compatible with the MVME2300/MVME2400 and MVME5100 in PMC mode. In PMC mode, 64 pins from PMC slot 1 and 46 pins from PMC slot 2 are available on P2 for PMC rear I/O. In IPMC mode, the MVME5500 series supports legacy MVME761 or MVME712M I/O modules (with limited PMC I/O) when an IPMC761 or IPMC712 PMC card is populated in PMC slot 1. In this configuration, PMC slot 2 contains some signals that are reserved for extended SCSI.

TRANSITION MODULES

The **MVME761** transition module provides industry-standard connector access to the IEEE 1284 parallel port, a 10BaseT or 100BaseT port via an RJ-45 connector, two DB-9 connectors providing access to the asynchronous serial ports configured as EIA-574 DTE and two HD-26 connectors providing access to the sync/async serial ports. These serial ports, labeled as Serial 3 and Serial 4 on the faceplate of the MVME761, are individually user-configurable as EIA-232, DCE or DTE via the installation of Emerson Serial Interface Modules (SIMs). A P2 adapter board provides interface signals to the MVME761 transition module. Two separate P2 adapter boards are available: one for 3-row backplanes and one for 5-row backplanes. The 3-row P2 adapter board provides connection for 8-bit SCSI. A 5-row P2 adapter board supports 16-bit SCSI and PMC I/O.

The **MVME712M** transition module provides industry-standard connector access to the Centronics parallel port, a narrow SCSI port, and four DB-25 connectors providing access to the asynchronous/synchronous serial ports jumper configurable as EIA-232 DCE or DTE. A P2 adapter board provides interface signals to the MVME712M transition module. The 3-row P2 adapter board also provides connection for 8-bit SCSI. To gain access to the additional user-definable I/O pins provided via the 5-row VME64 extension connector, a special P2 adapter board is available. This adapter panel replaces the traditional 3-row P2 adapter board and extends its capability by providing access to the PMC I/O pins.

Software Support

FIRMWARE MONITOR

Firmware must fulfill the traditional functions of power-on self-test (POST), initialization, low-level setup and debug, and operating system booting. Emerson's innovative firmware (known as MOTLoad) that is resident on the MVME5500 exceeds these requirements with expanded features such as interrupt driven I/O, more comprehensive power-up tests and extensive diagnostics with new scripting capability. And of course, MOTLoad provides a debugger interface similar to the time proven "bug" interface on previous VMEbus boards from Emerson.

OPERATING SYSTEMS AND KERNELS

WindRiver Systems VxWorks, TimeSys Linux, Green Hills Software INTEGRITY and LynuxWorks LynxOS are available for the MVME5500.

LIBRARIES

VSI/Pro VSIPL libraries from MPI Software Technology are available on the MVME5500. BETA 4.0 NDDS from Real Time Innovations (RTI) running over GbE and Native VME are available on the MVME5500 through RTI.

Specifications

PROCESSOR

- Microprocessor: MPC7457
- Clock Frequency: 1 GHz
- On-chip L1 Cache (I/D): 32KB/32KB
- On-chip L2 Cache (I/D): 512KB
- L3 Cache: 2MB

SYSTEM CONTROLLER

- Marvell GT-64260B

MAIN MEMORY

- Type: PC133 ECC SDRAM
- Speed: 133 MHz
- Configurations: 512MB in two banks

FLASH MEMORY

- Type: EEPROM, on-board programmable
- Capacity: 40MB total in two banks of 32MB and 8MB, both soldered
- Write Protection: 32MB of surface-mount flash is write protectable via jumper

NVRAM

- Capacity: 32KB (4KB available for users)
- Cell Storage Life: 50 years at 55 °C
- Cell Capacity Life: Five years at 100% duty cycle, 25 °C
- Removable Battery: Yes

COUNTERS/TIMERS

- TOD Clock Device: M48T37V
- Real-Time Timers/Counters: Eight, 32-bit programmable
- Watchdog Timer: Time-out generates reset

VMEBUS INTERFACE: ANSI/VITA 1-1994 VME64 (IEEE STD 1014)

- Controller: Tundra Universe II
- DTB Master: A16-A32; D08-D64, SCT, BLT
- DTB Slave: A24-A32; D08-D64, BLT, UAT
- Arbiter: RR/PRI
- Interrupt Handler/Generator: IRQ 1-7/Any one of seven IRQs
- System Controller: Yes, jumperable or auto detect
- Location Monitor: Two, LMA32

ETHERNET INTERFACES

- Port 1
 - ▲ Controller: Intel® 82545GM Gigabit Ethernet controller.
 - ▲ Interface Speed: 10/100/1000Mbps
 - ▲ Connector: Routed to front panel RJ-45
- Port 2
 - ▲ Controller: Controller integrated into GT-64260B system controller
 - ▲ Interface Speed: 10/100Mbps
 - ▲ Connector: Routed to front panel RJ-45 or optionally routed to P2, RJ-45 on MVME761

ASYNCHRONOUS SERIAL PORTS

- Controller: Two TL16C550C UARTs
- Number of Ports: Two, 16550 compatible
- Async Baud Rate, bps max.: 38.4K EIA-232, 115Kbps raw
- Connector: Routed to front panel RJ-45; one on planar for development use

DUAL IEEE P1386.1 PCI MEZZANINE CARD SLOTS

- Address/Data: A32/D32/D64, PMC PN1, PN2, PN3, PN4 connectors
- PCI Bus Clock: 33/66 MHz
- Signaling: 3.3V or 5V, configurable with keying pin
- Power: +3.3V, +5V, ±12V
- Module Types: Two single-wide or one double-wide, front panel or P2 I/O, PMC and PrPMC support

PCI EXPANSION CONNECTOR

- Address/Data: A32/D32/D64
- PCI Bus Clock: 33 MHz
- Signaling: 5V
- Power: +3.3V, +5V, ±12V
- Connector: 114-pin connector located on MVME5500 planar, same location as on MVME5100 planar

POWER REQUIREMENTS

	+5V ± 5%
MVME5500-0163:	6.7 A typ., 8.0 A max.
MVME5500-0163 with IPMC712/761:	7.6 A typ., 9.2 A max.

Note: In a 3-row chassis, PMC current should be limited to 19.8 watts (total of both PMC slots). In a 5-row chassis, PMC current should be limited to 46.2 watts (total of both PMC slots).

BOARD SIZE

- Height: 233.4 mm (9.2 in.)
- Depth: 160.0 mm (6.3 in.)
- Front Panel Height: 261.8 mm (10.3 in.)
- Width: 19.8 mm (0.8 in.)
- Max. Component Height: 14.8 mm (0.58 in.)

IPMC Modules

PMC INTERFACE

- Address/Data: A32/D32/D64, PMC PN1, PN2, PN3, PN4 connectors
- PCI Bus Clock: 33 MHz
- Signaling: 5V
- Module Type: Basic single-wide; P2 I/O

SCSI BUS

- Controller: Symbios 53C895A
- PCI Local Bus DMA: Yes, with PCI local bus burst
- Asynchronous (8-bit mode): 5.0MB/s
- Ultra SCSI: 20.0MB/s (8-bit mode), 40.0MB/s (16-bit mode)
- Note: 16-bit SCSI operation precludes the use of some PMC slot 2 signals.

SYNCHRONOUS SERIAL PORTS

- Controller: 85230/8536
- Number of Ports: Two (IPMC761); one (IPMC712)
- Configuration: IPMC761: TTL to P2 (both ports), SIM configurable on MVME761; IPMC712: EIA-232 to P2
- Baud Rate, bps max.: 2.5M sync, 38.4K async
- Oscillator Clock Rate (PCLK): 10 MHz/5 MHz

ASYNCHRONOUS SERIAL PORTS

- Controller: 16C550 UART; 85230/8536
- Number of Ports: Two (IPMC761); three (IPMC712)
- Configuration: EIA-574 DTE (IPMC761); EIA-232 (IPMC712)
- Async Baud Rate, bps max.: 38.4K EIA-232, 115Kbps raw

PARALLEL PORT

- Controller: PC97307
- Configuration: 8-bit bi-directional, full IEEE 1284 support; Centronics compatible (minus EPP and ECP on MVME712M)
- Modes: Master only

POWER REQUIREMENTS

(Additional power load placed on MVME5500 with IPMC installed)

	IPMC761	IPMC712
+5V:	0.5 A max.	0.5 A max.
+3.3V:	0.75 A max.	0.75 A max.

Transition Modules

I/O CONNECTORS

	MVME761	MVME712M
Asynchronous Serial Ports	Two, DB-9 labeled as COM1 and COM2	Three, DB-25 labeled Serial 1, Serial 2 and Serial 3
Synchronous Serial Ports	Two, HD-26 labeled as Serial 3 and Serial 4 (user-configurable via installation of SIMs); two 60-pin connectors on MVME761 planar for installation of two SIMs	One, DB-25 labeled as Serial 4
Parallel Port:	HD-36, Centronics compatible	D-36, Centronics compatible
Ethernet:	10BaseT or 100BaseT, RJ-45	Not available
SCSI	8- or 16-bit, 50- or 68-pin connector via P2 adapter	8-bit, standard SCSI D-50

BOARD SIZE

- Height: 233.4 mm (9.2 in.)
- Depth: 80.0 mm (3.1 in.)
- Front Panel Height: 261.8 mm (10.3 in.)
- Front Panel Width – MVME761: 19.8 mm (0.8 in.)
- Front Panel Width – MVME712M: 39.6 mm (1.6 in.)

All Modules

ENVIRONMENTAL

	Operating	Non-operating
Temperature:	0° C to +55° C (inlet air temp. with forced air cooling*)	-40° C to +85° C
Humidity (NC):	5% to 90%	5% to 90%
Vibration:		1 G sinusoidal, 5–100 Hz 2 axes horizontal and vertical (NEBS1)

*Note: Reference cooling requirements section of the user's manual.

DEMONSTRATED MTBF

Predicted MTBF 207,058 hours, calculated using
Bellcore Standard: Issue 6, Method 1, Case 3

ELECTROMAGNETIC COMPATIBILITY (EMC)

- Intended for use in systems meeting the following regulations:
 - ▲ U.S.: FCC Part 15, Subpart B, Class A (non-residential)
 - ▲ Canada: ICES-003, Class A (non-residential)
- Emerson board products are tested in a representative system to the following standards, results pending:
 - ▲ CE Mark per European EMC Directive 89/336/EEC with Amendments; Emissions: EN55022 Class A; Immunity: EN55024

SAFETY

All printed wiring boards (PWBs) are manufactured with a flammability rating of 94V-0 by UL recognized manufacturers.

Ordering Information		
NEW Part Number	Replaces	Description
MVME55006E-0161R	MVME55006E-0161	1 GHz MPC7457 PowerPC processor, 512MB SDRAM, Scanbe handles 6E
MVME55006E-0163R	MVME55006E-0163	1 GHz MPC7457 PowerPC processor, 512MB SDRAM, IEEE handles 6E
Related Products		
MVME712M6E	Transition module with one DB-25 sync/async serial port, three DB-25 async serial port, one AUI connector, one D-36 parallel port, and one 50-pin 8-bit SCSI; includes 3-row DIN P2 adapter board and cable 5E	
MVME7616E-001	Multifunction rear I/O PMC module; 8-bit SCSI, one parallel port, two async and two sync/async serial ports. Transition module with two DB-9 async serial port connectors, two HD-26 sync/async serial port connectors, one HD-36 parallel port connector, one RJ-45 10/100 Ethernet connector; includes 3-row DIN P2 adapter board and cable (for 8-bit SCSI) 5E	
MVME7616E-011	Transition module with two DB-9 async serial port connectors, two HD-26 sync/async serial port connectors, one HD-36 parallel port connector, one RJ-45 10/100 Ethernet connector; includes 5-row DIN P2 adapter board and cable (for 16-bit SCSI); requires backplane with 5-row DIN connectors 5E	
PMCSPAN16E-002	Primary PMCSPAN-002 with original VME Scanbe ejector handles 5E	
PMCSPAN16E-010	Secondary PMCSPAN-010 with original VME Scanbe ejector handles 5E	
Documentation		
V5500A/IH	MVME5500 Single-Board Computer Installation and Use	
V5500A/PG	MVME5500 Single-Board Computer Programmer's Reference Guide	
VME761A/IH	MVME761 Transition Module Installation and Use	
VME712MA/IH	MVME712M Transition Module Installation and Use	
MOTLODA/UM	MOTLoad Firmware Package User's Manual	
PMCSpanA/IH	PMCSpan PMC Adapter Carrier Board Installation and Use	





SOLUTION SERVICES

Emerson Network Power provides a portfolio of solution services optimized to meet your needs throughout the product lifecycle. Design services help speed time-to-market. Deployment services include global 24x7 technical support. Renewal services enable product longevity and technology refresh.

PowerPC is a trademark of IBM Corp. and used under license. Intel is a registered trademark of Intel Corporation or its subsidiaries in the U.S. and other countries. All other product or service names are the property of their respective owners.

This document identifies products, their specifications, and their characteristics, which may be suitable for certain applications. It does not constitute an offer to sell or a commitment of present or future availability, and should not be relied upon to state the terms and conditions, including warranties and disclaimers thereof, on which Emerson Network Power may sell products. A prospective buyer should exercise its own independent judgment to confirm the suitability of the products for particular applications. Emerson Network Power reserves the right to make changes, without notice, to any products or information herein which will, in its sole discretion, improve reliability, function, or design. Emerson Network Power does not assume any liability arising out of the application or use of any product or circuit described herein; neither does it convey any license under its patent or other intellectual property rights or under others. This disclaimer extends to any prospective buyer, and it includes Emerson Network Power's licensee, licensee's transferees, and licensee's customers and users. Availability of some of the products and services described herein may be restricted in some locations.

Emerson Network Power.
The global leader in enabling
Business-Critical Continuity™.

-  AC Power
-  Embedded Power
-  Precision Cooling
-  Connectivity
-  Infrastructure Management & Monitoring
-  Racks & Integrated Cabinets
-  DC Power
-  Outside Plant
-  Services
-  Embedded Computing
-  Power Switching & Controls
-  Surge Protection

Emerson Network Power

Offices: Tempe, AZ U.S.A. 1 800 759 1107 or +1 602 438 5720
Paris, France +33 1 60 92 31 20 • Munich, Germany +49 8996 082564 • Tel Aviv, Israel +972 9 9560361
Hong Kong +852 2176 3540 • Shanghai, China +86 21 3395 0289 • Tokyo, Japan +81 3 5403 2730 • Seoul, Korea +82 2 3483 1500

EmersonNetworkPower.com/EmbeddedComputing

Emerson and the Emerson Network Power logo are trademarks of Emerson Electric Co. ©2013 Emerson Electric Co. All rights reserved.